

English

249  
PO

## IMPORTANT SAFETY RULES

Read, understand, and follow all instructions carefully before installing and using this product.

# Cartridge Filter Pump & Saltwater System with E.C.O. (Electrocatalytic Oxidation) Model ECO7111



For illustrative purposes only.

Don't forget to try these other fine Intex products: Pools, Pool Accessories, Inflatable Pools and In-Home Toys, Airbeds and Boats available at fine retailers or visit our website listed below. Due to a policy of continuous product improvement, Intex reserves the right to change specifications and appearance, which may result in updates to the instruction manual without notice.



## IMPORTANT! DO NOT RETURN PRODUCT TO STORE

To purchase parts and accessories or to obtain non-technical assistance, Visit  
[www.intexcorp.com](http://www.intexcorp.com)

For technical assistance and missing parts call us toll-free (for U.S. and Canadian Residents):

**1-800-234-6839**

Monday through Friday, 8:30am to 5:00pm Pacific Time

249-\*PO-R0-1804

OWNER'S MANUAL

## TABLE OF CONTENTS

<b>Warnings.....</b>	<b>3</b>
<b>Parts References.....</b>	<b>4-5</b>
<b>Product Information &amp; Specifications.....</b>	<b>6</b>
<b>Setup Instructions.....</b>	<b>7-10</b>
<b>Salt &amp; Pool Water Volumes.....</b>	<b>11</b>
<b>Intex Pools Salt Table.....</b>	<b>12</b>
<b>Intex Pools Cyanuric Acid Table.....</b>	<b>13</b>
<b>Intex Pools Operating Time Table.....</b>	<b>14</b>
<b>Non-Intex Pools Salt Table.....</b>	<b>15</b>
<b>Non-Intex Pools Cyanuric Acid Table.....</b>	<b>15</b>
<b>Non-Intex Pools Operating Time Table.....</b>	<b>15</b>
<b>Operating Instructions.....</b>	<b>16-18</b>
<b>LED Code Chart.....</b>	<b>19</b>
<b>Maintenance.....</b>	<b>20-22</b>
<b>Long Term Storage.....</b>	<b>23</b>
<b>Pool Maintenance and Chemical Definitions.....</b>	<b>24</b>
<b>Troubleshooting Guide.....</b>	<b>25-27</b>
<b>General Aquatic Safety.....</b>	<b>28</b>
<b>Limited Warranty.....</b>	<b>29</b>

# IMPORTANT SAFETY RULES

Read, Understand and Follow All Instructions Carefully Before Installing and Using this Product.

## READ AND FOLLOW ALL INSTRUCTIONS

### WARNING

- To reduce the risk of injury, do not permit children to use this product. Always supervise children and those with disabilities.
- Children must stay away from this product and electrical cord(s).
- Assembly and disassembly by adults only.
- For outdoor use only.
- Not to energize or operate the unit if the appliance is damaged or improperly assembled.
- Risk of electric shock. Connect only to a grounding type receptacle, this product is provided with a ground-fault circuit interrupter. If replacement of the plug or cord is needed, use only identical replacement parts.
- Always unplug this product from the electrical outlet before removing, cleaning, servicing or making any adjustment to the product.
- The unit is provided with a ground-fault circuit interrupter (GFCI). To test the GFCI, push the test button. The GFCI should interrupt power. Push the reset button, power should be restored. If the GFCI fails to operate in this manner. The GFCI is defective. If the GFCI interrupts power to the pump without the test button being pushed, a ground current is flowing, indicating the possibility of an electric shock. Do not use this pump. Disconnect the pump and have the problem corrected by a qualified service representative before using.
- Do not bury the electrical cord. Locate the cord where it will not be damaged by lawn mowers, hedge trimmers and other equipment.
- To reduce the risk of electric shock, replace damaged cord immediately. Use a qualified electrician to replace the cord.
- To reduce the risk of electric shock, do not use extension cords, timers, plug adaptors or converter plugs to connect unit to electric supply; provide a properly located outlet.
- Do not attempt to plug in or unplug this product while standing in water or when your hands are wet.
- Do not use an appliance leakage current interrupter (ALCI) in place of a GFCI since the ALCI will not protect people.
- Position this product away from the pool, so as to prevent children from climbing on and accessing the pool.
- Do not operate this product when the pool is occupied.
- Never use the pool if indicated chlorine level is more than 3ppm.
- This product is intended to be used only for the purposes described in the manual!
- Operating this product without water flowing through the system can cause a build up of flammable gases which can result in FIRE OR EXPLOSION.

**FAILURE TO FOLLOW THESE WARNINGS MAY RESULT IN PROPERTY DAMAGE, ELECTRIC SHOCK, ENTANGLEMENT OR OTHER SERIOUS INJURY OR DEATH.**

### CAUTION

This product is for use with storable pools only. Do not use with permanently-installed pools. A storable pool is constructed so that it is capable of being readily disassembled for storage and reassembled to its original integrity. A permanently-installed pool is constructed in or on the ground or in a building such that it cannot be readily disassembled for storage.

To reduce the risk of electric shock the pool must be installed no closer than 6 feet (1.8 m) from any electrical outlet. Do not place portable appliances closer than 5 feet (1.5 m) from the pool.

These product warnings, instructions and safety rules provided with the product represent some common risks of water recreation devices and do not cover all instances of risk and danger. Please use common sense and good judgement when enjoying any water activity.

## PARTS REFERENCE

Before assembling your product, please take a few minutes to check the contents and become familiar with all the parts.

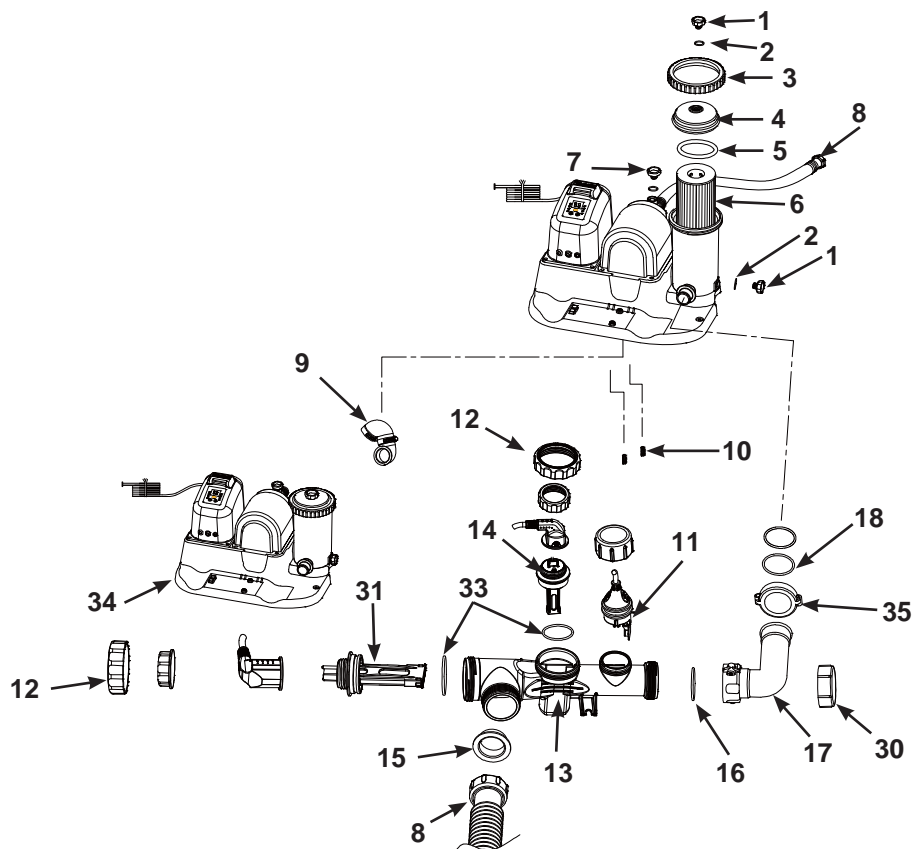

Parts shown on this page are supplied with the pool package and are shown here for assembly purposes only.

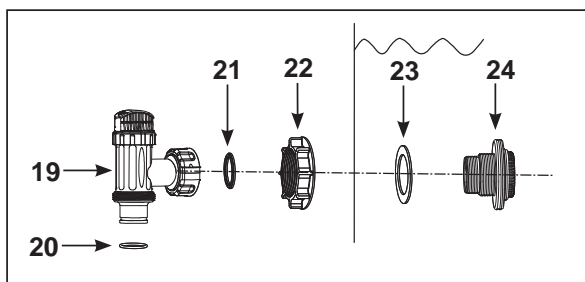
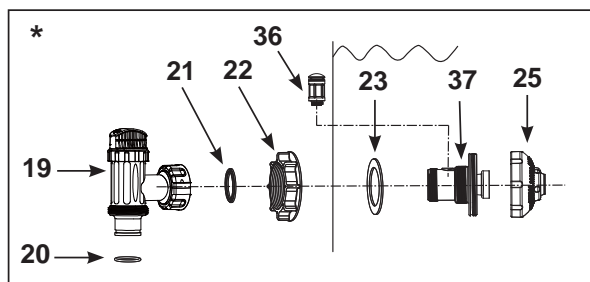

**NOTE:** Drawings for illustration purpose only. Actual product may vary. Not to scale. No tools are required for the assembly.

\* If this pump was not purchased as part of a pool set, the above parts can be ordered at [www.intexcorp.com](http://www.intexcorp.com) if needed.

## PARTS REFERENCE (continued)

Before assembling your product, please take a few minutes to check the contents and become familiar with all the parts.

REF. NO.			DESCRIPTION	QTY.	SPARE PART NO.
SMALL AGP	LARGE AGP	COMMON PARTS			
		1	AIR RELEASE VALVE/SEDIMENT RELEASE VALVE	2	10460
		2	VALVE O-RING	2	10264
		3	THREADED FILTER HOUSING COLLAR	1	10749
		4	FILTER HOUSING COVER	1	10750
		5	FILTER HOUSING O-RING	1	10325
		6	FILTER CARTRIDGE (29000)	1	
		7	AIR RELEASE VALVE B (WITH O-RING)	1	10725
		8	PUMP HOSE WITH NUTS	2	11009
		9	WATER TRANSFER HOSE (WITH COLLAR AND 2 HOSE CLAMPS)	1	11583
		10	SCREW	2	11519
		11	FLOW SENSOR	1	11460
		12	ELECTROLYTIC CELL NUT	2	11582
		13	ELECTROLYTIC CELL (O-RING C INCLUDED)	1	11906
		14	E.C.O. ELECTRODE	1	11900
		15	L-SHAPE O-RING	1	11228
		16	O-RING C	1	10712
		17	ANGLE JOINT (O-RING D INCLUDED)	1	11584
		18	O-RING A	1	11587
		19*	PLUNGER VALVE (HOSE O-RING & STEP WASHER INCLUDED)	2	10747
		20*	HOSE O-RING	2	10262
		21*	STEP WASHER	2	10745
	22*		STRAINER NUT	2	10256
	23*		FLAT STRAINER RUBBER WASHER	2	10255
	24*		THREADED STRAINER CONNECTOR	1	11235
	25*		ADJUSTABLE POOL INLET JET NOZZLE	1	12369
26*			ADAPTOR B	2	10722
27*			STRAINER CONNECTOR	1	11070
28*			POOL INLET JET NOZZLE	1	12364
29*			STRAINER GRID	1	11072
		30	CELL COVER	1	11131
		31	TITANIUM ELECTRODE	1	11899
		32	TEST STRIPS	1	19635
		33	TITANIUM ELECTRODE O-RING	2	11585
		34	CONTROL STATION	1	11909
		35	COLLAR NUT	1	11604
	36*		AIR JET VALVE	1	12363
	37*		INLET THREADED AIRCONNECTOR	1	12371
38*			INLET STRAINER CONNECTOR	1	12365
39*			POOL INLET AIR ADAPTOR	1	12368
		40*	AIR JET VALVE CAP (NOT SHOWN)	1	12373

" \* ": Optional.

When ordering parts, be sure to quote the model number and part numbers.

**SAVE THESE INSTRUCTIONS**

## HOW SANITIZER IS GENERATED

This product is specially designed for above ground pools. It will destroy the bacteria, oxidize bather organics and control algae, which provide a safe, clean and comfortable swimming pool.

Common salt (sodium chloride) is made up of two elements, sodium and chlorine. During the installation of your Saltwater System/Filter Pump, a measured quantity of salt is dissolved in the pool water to make it slightly salty. The pool water flows through the saltwater system's electrolytic cell to produce HClO. The HClO dissolves in the water and instantly starts destroying bacteria and algae. It also oxidizes all other organic materials.

## HOW THE ELECTROCATALYTIC OXIDATION WORKS

The Electrolytic Oxidation (E.C.O.) is an Advanced Oxidation Processes (AOPs). When direct current is applied to the electrocatalytic oxidation electrodes, water will be discharged to generate "hydroxyl radicals". The hydroxyl radical is a powerful oxidant, which oxidizes organic contaminants, and destroys bacteria and algae. Hydroxyl radicals in combination with free available chlorine provide the strongest and safest pool water sanitation.

## PRODUCT SPECIFICATIONS

Power:	110 - 120 Volt
Amperage:	Saltwater System - 0.6 A; Filter Pump - 1.5 A
Ideal Salt Level:	3000 ppm (parts per million)
Maximum Sanitizer Output/hour:	5 grams/hour
E.C.O. Cell Output Current:	500 mA
Limited Warranty:	see "Limited Warranty"

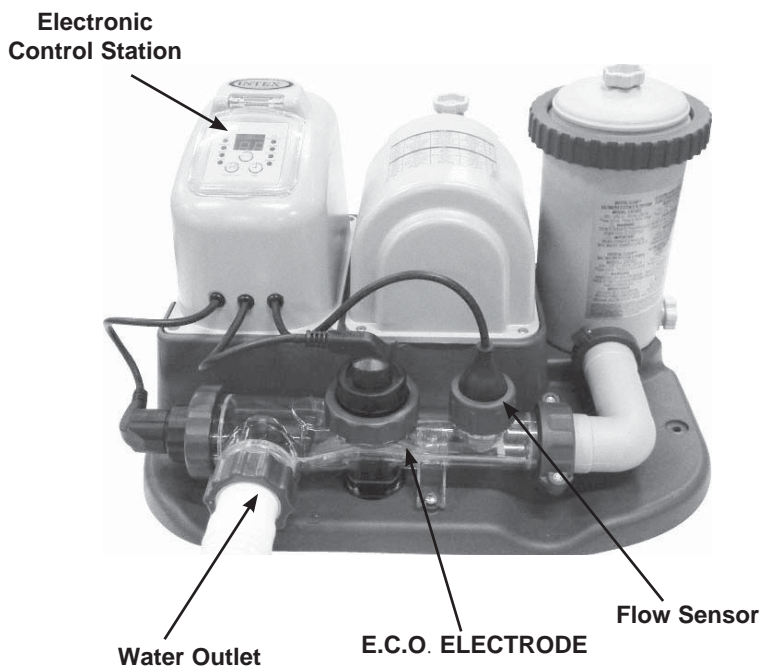

## STRAINER & PLUNGER VALVE SETUP

Please visit [www.intexcorp.com](http://www.intexcorp.com) for the latest instructional video on the installation and operation of this product.

### IMPORTANT

The Saltwater System/Filter Pump must be installed as the last piece of pool equipment in the water return line to the pool. This location extends the life of the titanium plates.

#### Strainer & Plunger Valve Setup (small AGP)

The strainer grid prevents large objects from jamming and/or damaging the filter pump. The plunger valve assembly prevents water from flowing into the filter pump while the filter cartridge is being placed or cleaned. If your pool has an inflatable top ring, install the strainer, nozzle and plunger valve before inflating the pool liner top ring. The parts numbers here onward, refer to the parts depicted in the Parts List section of this manual. To install, do the following:

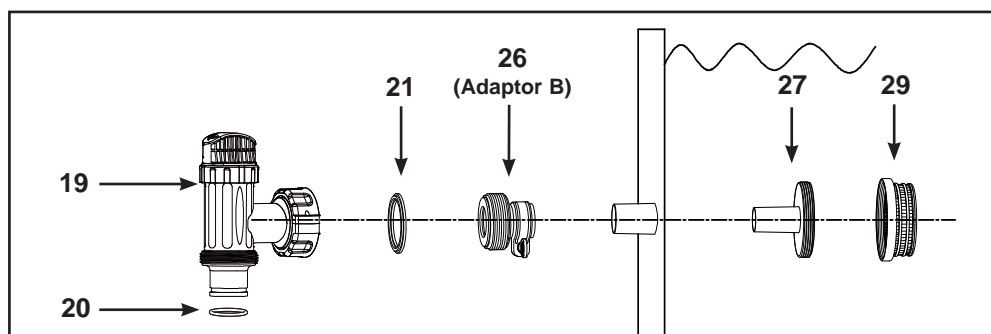
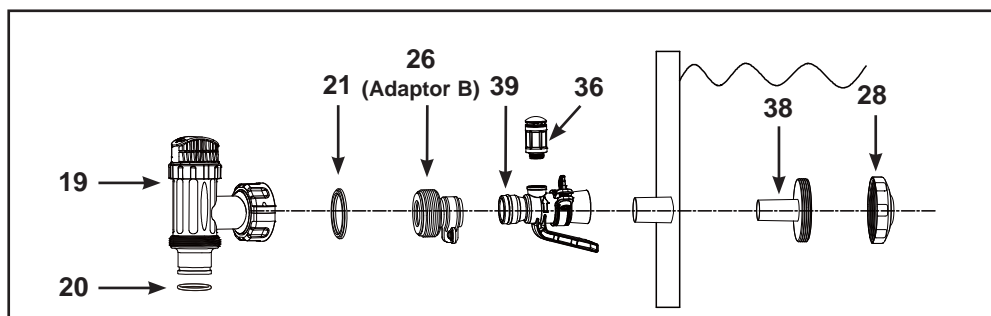

## POOL OUTLET - STRAINER & PLUNGER VALVE SETUP (OPTIONAL)

The strainer grid prevents large objects from jamming and/or damaging the filter pump. If your pool has an inflatable top ring, install the strainer, nozzle and plunger valve before inflating the pool liner top ring. The part numbers here onward refer to the parts depicted in the Parts List section of this manual. To install, do the following:

1. In a counter-clockwise motion unscrew plunger valve union from the threaded strainer connector (24) (see drawing 1). Be careful not to lose the step rubber washer (21). Place the plunger valve on the ground in a safe place.
2. In a counter-clockwise motion unscrew the strainer nut (22) from the threaded connector (24). Leave the flat washer (23) on the connector (24).
3. Install the strainer and plunger valve at the lower position of pool outlet (marked "+"). From the inside of the pool liner insert the connector (24) into one of the pre-cut holes with the washer remaining on the connector to be placed against the inside of the liner wall.
4. Before assembly, lubricate the threads with a petroleum jelly. Then, with the flat side of the strainer nut (22) facing the outside wall of the liner in a clockwise motion screw the strainer nut (22) back onto the threaded connector (24) (see drawing 2).
5. Finger tighten the strainer nut (22) onto the threaded connector (24).
6. Grasp the plunger valve assembly. Make sure the step washer (21) is in place.
7. In a clockwise motion screw the plunger valve union back onto the threaded connector (24) (see drawing 3).
8. In a clockwise motion turn the plunger valve handle to close position. Ensure the plunger valve is securely closed. This will prevent water from flowing out during filling of the pool (see drawing 4).

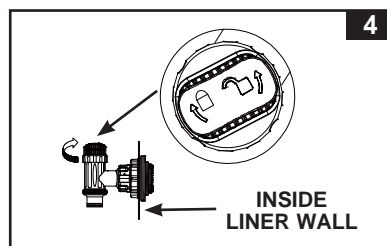
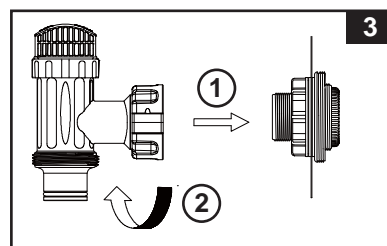
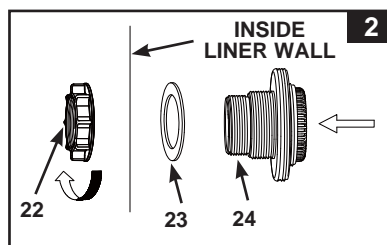
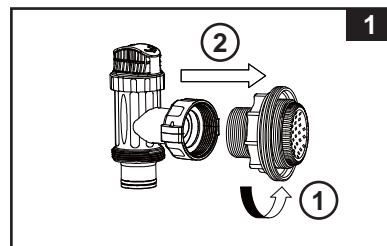



## POOL INLET - NOZZLE & PLUNGER VALVE SETUP (OPTIONAL)

1. In a counter-clockwise motion unscrew plunger valve union from the inlet threaded air connector (37) (see drawing 5). Be careful not to lose the step rubber washer (21). Place the plunger valve on the ground in a safe place.
2. In a counter-clockwise motion unscrew the strainer nut (22) from the inlet threaded air connector (37). Leave the flat washer (23) on the connector (37).
3. Install the nozzle and plunger valve at the upper position of pool inlet. From the inside of the pool liner insert the nozzle union (25 & 37) into one of the pre-cut holes with the washer remaining on the connector to be placed against the inside of the liner wall.
4. Before assembly, lubricate the threads with a petroleum jelly. Then, with the flat side of the strainer nut (22) facing the outside wall of the liner in a clockwise motion screw the strainer nut (22) back onto the inlet threaded air connector (37) (see drawing 6).
5. Finger tighten the adjustable pool inlet jet nozzle (25) and the strainer nut (22) onto the inlet threaded air connector (37).
6. Grasp the plunger valve assembly. Make sure the step washer (21) is in place.
7. Screw the air jet valve (36) over the inlet threaded air connector (37). **NOTE:** Make sure the air jet valve is securely tighten and facing up. In a clockwise motion screw the plunger valve union back onto the inlet threaded air connector (37) (see drawing 7).
8. In a clockwise motion turn the plunger valve handle to close position. Ensure the plunger valve is securely closed. This will prevent water from flowing out during filling of the pool (see drawing 8).
9. Adjust the direction of the nozzle head pointing away from the pool outlet for a better circulation result (see drawing 9).
10. The pool liner is now ready to be filled with water. Consult the above-ground-pool owner's manual for the filling instructions.

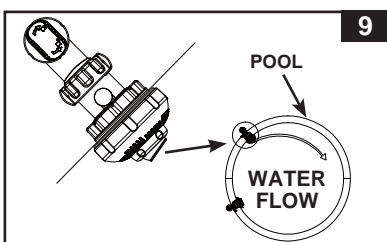
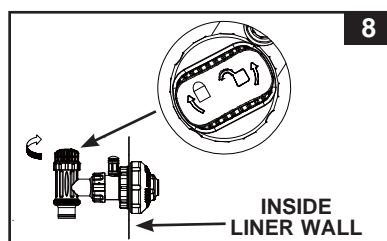
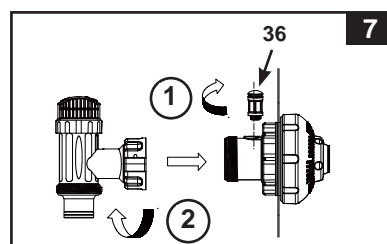
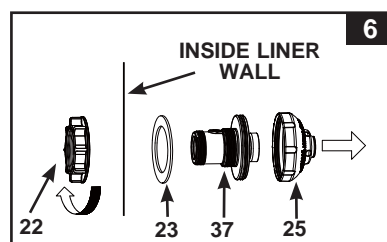
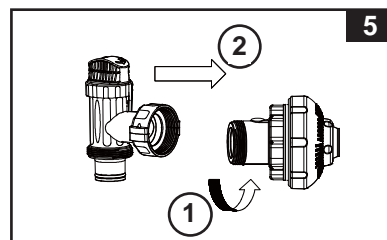

## SALTWATER SYSTEM/FILTER PUMP

### Saltwater System/Filter Pump

1. Remove the Saltwater System/Filter Pump and hoses from the packaging.
2. Place the Saltwater System/Filter Pump in a location for hose **(8)** connections to the plunger valve assemblies.

**NOTE: Some regional regulations may require the filter pump to be mounted on a stationary platform. There are two mounting holes located in the pump base for this reason. Consult your local authorities for filter pump mounting requirements.**

3. Grasp the two pump hoses **(8)** and connect the hose nuts to the Saltwater System/Filter Pump.
4. In a counter-clockwise motion unscrew the threaded filter housing collar **(3)** from the filter housing. Place it in a safe place.
5. The Saltwater System/Filter Pump is an airtight system. In a counter-clockwise motion turn both air release valves **(1 & 7)** 1 - 2 turns to open. **DO NOT remove air release valves as water will expel with force if the motor is turned on and injury may occur.**
6. Grasp and remove the filter housing cover **(4)**. Check to see if a cartridge is inside the housing. If yes, replace the cover, finger tighten the housing collar **(3)** back onto the filter housing.
7. Gently finger tighten the sediment release valve located at the bottom of the housing to be sure that water does not leak out.
8. When the pool is filled connect the hose from the electrolytic cell outlet to the highest strainer assembly. You will find the hose connection at the bottom of the plunger valve assembly. Use the hose nut to attach the hose.
9. Connect the second hose to the middle of the motor housing and to the remaining liner connection.

## IMPORTANT

**To prevent air lock, open the lower plunger valve (connected inlet hose) first and then the upper plunger valve (connected outlet hose). Open air release valves, lift and lower the inlet hose until water starts to flow out of the air release valves, close air release valves.**

## SALT & POOL WATER VOLUMES

### • Which kind of salt to use:

#### Use only Sodium Chloride Salts



Use only sodium chloride (NaCl) salt that is at least 99.8% pure. It is also acceptable to use water conditioning salt pellets (the compressed forms of evaporated salt). However, it will take a longer time for them to dissolve. **Do not use iodized or yellow (yellow prussiate of soda) colored salt.** Salt is added to the pool water and the electrolytic cell uses this salt to create the sanitizer. The purer the salt the better the performance of the electrolytic cell.

### • Optimum Salt Levels

The ideal salt level in the pool water is between 2500-3500 ppm (parts per million). The optimal level is 3000 ppm.

A too low salt level will reduce the efficiency of the saltwater system and result in low sanitizer production. A high salt level may generate a salty taste to the pool water (this may occur at a salt level above 3500-4000 ppm). Too high of a salt level may damage the power supply and cause corrosion to pool metal fixtures and accessories. The Salt Table page of this manual, shows the correct dosage of salt needed. The salt in the pool is constantly recycled. Salt loss occurs only when pool water is physically removed from the pool. Salt is not lost due to evaporation.

### • Adding Salt

1. Switch on the unit, then press and hold both  and  button for 5 seconds, the LED flashes "FP". The unit is now in a Filter pump working mode and switch the filter pump on to start the water circulation.
2. Keep the saltwater system turned off.
3. Determine the amount of salt to be added (see "Salt Table").
4. Evenly spread the proper amount of salt around the inside perimeter of the pool.
5. Avoid clogging the filter by not adding salt through the skimmer.
6. Brush the pool bottom to speed up the dissolving process. Do not allow salt to pile up on the bottom of the pool. Run the filter pump 24 consecutive hours to thoroughly dissolve the salt.
7. After 24 hours and if all the salt is dissolved, turn on the Saltwater System, press  button until you hear a "beep", code "00" flashing (see "System Operation" section steps 2 to 4) and set the saltwater system to desired operating time (see "Operating Time Table").

### • Removing Salt

If too much salt has been added, the unit will beep and display "code 92" (see "Alarm Codes"). You will need to lower the salt concentration. The only way to do so, is to partially drain the pool and refill it with fresh water. Drain and refill approximately 20% of the pool's water until the "Code 92" disappears.

### • Pool Volume Calculation

Types of Pool	Gallons (pool size in feet)	Cubic Meters (pool size in meters)
Rectangular	Length x Width x Average Depth x 7.5	Length x Width x Average Depth
Circular	Length x Width x Average Depth x 5.9	Length x Width x Average Depth x 0.79
Oval	Length x Width x Average Depth x 6.0	Length x Width x Average Depth x 0.80

## INTEX POOLS SALT TABLE

This table shows the amount of salt needed to achieve and maintain the optimal 3000 ppm salt level.

Pool Size	Water Capacity (Calculated at 90% for Frame Pool and 80% for Easy Set & Oval Pool)		Salt Needed for Startup 3.0g/L (3000ppm)		Salt Needed when Low Salt Detected (CODE "91")		
	(Gals)	(Liters)	(Lbs)	(Kgs)	(Lbs)	(Kgs)	
<b>INTEX ABOVE GROUND POOLS (AGP's)</b>							
<b>EASY SET® POOL</b>	457cmx84cm(15'x33")	2587	9792	65	30	20	10
	457cmx91cm(15'x36")	2822	10681	65	30	20	10
	457cmx107cm(15'x42")	3284	12430	80	35	20	10
	457cmx122cm(15'x48")	3736	14141	95	45	25	10
	488cmx107cm(16'x42")	3754	14209	95	45	25	10
	488cmx122cm(16'x48")	4273	16173	110	50	30	15
	488cmx132cm(16'x52")	4614	17464	115	50	30	15
	549cmx107cm(18'x42")	4786	18115	120	55	30	15
549cmx122cm(18'x48")	5455	20647	135	60	35	15	
<b>CIRCULAR METAL FRAME POOL</b>	457cmx91cm(15'x36")	3282	12422	80	35	20	10
	457cmx107cm(15'x42")	3861	14614	100	45	25	10
	457cmx122cm(15'x48")	4440	16805	110	50	30	15
	488cmx122cm(16'x48")	5061	19156	125	55	35	15
	549cmx122cm(18'x48")	6423	24311	160	75	40	20
<b>ULTRA FRAME® POOL</b>	488cmx122cm(16'x48")	5061	19156	125	55	35	15
	549cmx122cm(18'x48")	6423	24311	160	75	40	20
<b>GRAPHITE GRAY PANEL POOL SET™</b>	478cmx124cm(15'8"x49")	4440	16805	110	50	30	15
	508cmx124cm(16'8"x49")	5061	19156	125	55	35	15
<b>OVAL FRAME POOL</b>	305cmx549cmx107cm(10'x18'x42")	2885	10920	70	30	20	10
	366cmx610cmx122cm(12'x20'x48")	4393	16628	110	50	30	15
<b>RECT. ULTRA FRAME POOL</b>	274cmx457cmx122cm(9'x15'x48")	3484	13187	90	40	25	10
	274cmx549cmx132cm(9'x18'x52")	4545	17203	115	50	30	15
	305cmx610cmx132cm(10'x20'x52")	5835	22085	145	65	40	20

## INTEX POOLS CYANURIC ACID TABLE

Cyanuric acid is a chemical that reduces the loss of chlorine in water due to ultraviolet rays. To maintain the pool water clear and clean, and to maximize the performance of the device, add cyanuric acid to the pool. We recommend that the cyanuric acid level be maintained at approximately 1% of the salt, i.e. 100 Lbs (45 Kgs) salt x1% = 1 Lbs (0.45 Kgs) cyanuric acid.

If the pool water is dirty, filthy or grimy, DO NOT add chlorine stabilizer (cyanuric acid) as this will slowdown the sanitation time of the device. Under this condition you must BOOST your pool water, refer to BOOST cycle steps. Once the pool water has been restored to clear and clean conditions you may add cyanuric acid.

Pool Size	Water Capacity (Calculated at 90% for Frame Pool and 80% for Easy Set & Oval Pool)		Cyanuric Acid Needed for Startup 0.03g/L (30ppm)		
	(Gals)	(Liters)	(Lbs)	(Kgs)	
<b>INTEX ABOVE GROUND POOLS (AGP's)</b>					
<b>EASY SET® POOL</b>	457cmx84cm(15'x33")	2587	9792	0.6	0.3
	457cmx91cm(15'x36")	2822	10681	0.7	0.3
	457cmx107cm(15'x42")	3284	12430	0.8	0.4
	457cmx122cm(15'x48")	3736	14141	0.9	0.4
	488cmx107cm(16'x42")	3754	14209	0.9	0.4
	488cmx122cm(16'x48")	4273	16173	1.1	0.5
	488cmx132cm(16'x52")	4614	17464	1.2	0.5
	549cmx107cm(18'x42")	4786	18115	1.2	0.5
549cmx122cm(18'x48")	5455	20647	1.4	0.6	
<b>CIRCULAR METAL FRAME POOL</b>	457cmx91cm(15'x36")	3282	12422	0.8	0.4
	457cmx107cm(15'x42")	3861	14614	1.0	0.4
	457cmx122cm(15'x48")	4440	16805	1.1	0.5
	488cmx122cm(16'x48")	5061	19156	1.3	0.6
	549cmx122cm(18'x48")	6423	24311	1.6	0.7
<b>ULTRA FRAME® POOL</b>	488cmx122cm(16'x48")	5061	19156	1.3	0.6
	549cmx122cm(18'x48")	6423	24311	1.6	0.7
<b>GRAPHITE GRAY PANEL POOL SET™</b>	478cmx124cm(15'8"x49")	4440	16805	1.1	0.5
	508cmx124cm(16'8"x49")	5061	19156	1.3	0.6
<b>OVAL FRAME POOL</b>	305cmx549cmx107cm(10'x18'x42")	2885	10920	0.7	0.3
	366cmx610cmx122cm(12'x20'x48")	4393	16628	1.1	0.5
<b>RECT. ULTRA FRAME POOL</b>	274cmx457cmx122cm(9'x15'x48")	3484	13187	0.9	0.4
	274cmx549cmx132cm(9'x18'x52")	4545	17203	1.1	0.5
	305cmx610cmx132cm(10'x20'x52")	5835	22085	1.5	0.7

## INTEX POOLS OPERATING TIME TABLE (WITH CYANURIC ACID)

Pool Size		Water Capacity (Calculated at 90% for Frame Pool and 80% for Easy Set & Oval Pool)		Operating Time (hours) at different ambient/air temperatures		
		(Gals)	(Liters)	10 - 19°C (50 - 66°F)	20 - 28°C (68 - 82°F)	29 - 36°C (84 - 97°F)
<b>INTEX ABOVE GROUND POOLS (AGP's)</b>						
<b>EASY SET® POOL</b>	457cmx84cm(15'x33")	2587	9792	3	3	4
	457cmx91cm(15'x36")	2822	10681	3	4	5
	457cmx107cm(15'x42")	3284	12430	3	4	5
	457cmx122cm(15'x48")	3736	14141	4	5	6
	488cmx107cm(16'x42")	3754	14209	4	5	6
	488cmx122cm(16'x48")	4273	16173	4	5	6
	488cmx132cm(16'x52")	4614	17464	5	6	7
	549cmx107cm(18'x42")	4786	18115	5	6	7
549cmx122cm(18'x48")	5455	20647	6	7	8	
<b>CIRCULAR METAL FRAME POOL</b>	457cmx91cm(15'x36")	3282	12422	3	4	5
	457cmx107cm(15'x42")	3861	14614	4	5	6
	457cmx122cm(15'x48")	4440	16805	5	6	6
	488cmx122cm(16'x48")	5061	19156	5	6	7
	549cmx122cm(18'x48")	6423	24311	7	8	9
<b>ULTRA FRAME® POOL</b>	488cmx122cm(16'x48")	5061	19156	5	6	7
	549cmx122cm(18'x48")	6423	24311	7	8	9
<b>GRAPHITE GRAY PANEL POOL SET™</b>	478cmx124cm(15'8"x49")	4440	16805	5	6	6
	508cmx124cm(16'8"x49")	5061	19156	5	6	7
<b>OVAL FRAME POOL</b>	305cmx549cmx107cm(10'x18'x42")	2885	10920	3	4	5
	366cmx610cmx122cm(12'x20'x48")	4393	16628	5	5	6
<b>RECT. ULTRA FRAME POOL</b>	274cmx457cmx122cm(9'x15'x48")	3484	13187	3	4	5
	274cmx549cmx132cm(9'x18'x52")	4545	17203	5	6	7
	305cmx610cmx132cm(10'x20'x52")	5835	22085	6	7	8

## SALT CALCULATION FORMULA FOR ALL POOLS

Salt Needed for Startup (Lbs)	Salt Needed for Startup (Kgs)	Salt Needed when Low Salt Detected (Lbs)	Salt Needed when Low Salt Detected (Kgs)
Water Capacity (Gals) x 0.025	Water Capacity (Liters) x 0.003	Water Capacity (Gals) x 0.0067	Water Capacity (Liters) x 0.0008

## SALT TABLE FOR COMMON NON-INTEX POOLS

Water Capacity		Salt Needed for Startup		Salt Needed when Low Salt Detected (CODE "91")	
(Gals)	(Liters)	(Lbs)	(Kgs)	(Lbs)	(Kgs)
2000	7500	50	20	10	5
4000	15000	100	45	25	10
6000	22500	150	65	40	20
7000	26500	175	80	55	20

## CYANURIC ACID TABLE FOR COMMON NON-INTEX POOLS

Water Capacity		Cyanuric Acid Needed for Startup 0.03g/L (30ppm)	
(Gals)	(Liters)	(Lbs)	(Kgs)
2000	7500	0.50	0.23
4000	15000	1.00	0.45
6000	22500	1.50	0.68
7000	26500	1.75	0.80

## OPERATING TIME TABLE FOR COMMON NON-INTEX POOLS (WITH CYANURIC ACID)

Water Capacity		Operating Time (hours) at different ambient/air temperatures		
(Gals)	(Liters)	10 - 19°C (50 - 66°F)	20 - 28°C (68 - 82°F)	29 - 36°C (84 - 97°F)
2000	7500	2	3	4
4000	15000	4	5	6
6000	22500	6	7	8
7000	26500	7	8	9



## FILTER PUMP OPERATION

1. Make sure the unit is switched off. The switch is located on the control station.
2. Connect the power cord to a GFCI protected electrical outlet.

### **⚠ WARNING**

**Risk of electric shock. Connect this product only to a grounding type receptacle protected by a ground-fault circuit interrupter (GFCI). Contact a qualified electrician if you cannot verify that the receptacle is protected by a GFCI.**

### **IMPORTANT**

**To prevent air lock, open the lower plunger valve (connected inlet hose) first and then the upper plunger valve (connected outlet hose). Open air release valves, lift and lower the inlet hose until water starts to flow out of the air release valves, close air release valves.**

3. Turn both plunger valve handles fully counter-clockwise until they stop. This opens the valve, allowing water to flow into the filter pump.
4. With water flowing into unit, the water pressure will allow the air trapped inside to escape from the air release valves (**1 & 7**). When all the air has escaped water will flow out of the valves (**1 & 7**). When this occurs gently finger tighten the valves in a clockwise direction.
5. Turn on the switch. The filter pump is now filtering the water.
6. The green "Pump" light on the control panel will light up, that indicates the filter pump is running.

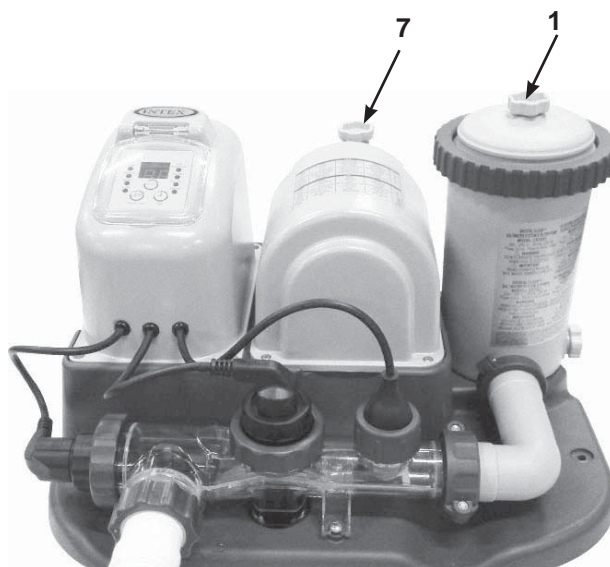



## SALTWATER SYSTEM OPERATION

### 1. Start up the unit:

Plug the power cord into the electrical outlet and test the GFCI/RCD (circuit breaker). Switch on the unit. With the Filter Pump turned "ON" and operating. The green "Pump" light on the control panel will be on and flashing code "00" appears on the electronic control station's LED, indicating that the unit is ready to be programmed. This is normal.



### 2. Set operating hours for Saltwater System:

With code "00" flashing, press button to set the desired operating hours. See the "Operating Time Table" for the required operating hours related to each pool size. Pressing will increase the time from 01 to 12 hours maximum. If you have selected too many hours keep pressing to repeat the cycle. The built-in timer will now activate your Saltwater System, at the same time each day, for the number of hours you have set.

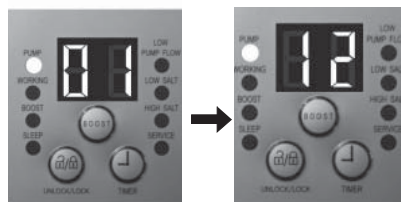

(1 to 12 hours max per cycle)

**NOTE:** The Saltwater System will not operate if the filter pump is not operating.

### 3. Lock keypad controls:

With the desired hour value showing, press button until you hear a "beep". The green "WORKING" indicator on the control panel will light up within a few seconds to indicate that the saltwater system has started sanitizer production. Locking the control buttons into this setting prevents unauthorized changing of the operating cycle.



**NOTE:** If you forget to lock the keypad controls, the system will automatically lock it and start working 1 minute later.

### 4. Unlock & Readjust operating time if necessary:

The operating hours can be re-adjusted if necessary. Press button until you hear a "beep" to unlock the keypad and the current programmed time will flash. Repeat steps 2 to 3.





## SALTWATER SYSTEM OPERATION (continued)

### 5. Boost cycle

- First time installation, press and hold "BOOST" button for 5 seconds until the indicator lights up and the LED display "80". This indicates that the saltwater system has started E.C.O. and more chlorine sanitizer production. You can press and hold the "BOOST" button for another 5 seconds until the indicator is off, which will cancel the Boost cycle.
- The boost operating hours is 8 times the amount of time programmed into the system, i.e. if your saltwater system operating time is 2 hours, the boost procedure will run  $8 \times 2 = 16$  hours. After boost procedure has been completed, the system will automatically switch to the normal working mode.
- After a heavy rain or if the pool is dirty, press the "BOOST" button to shock the pool again.





### 6. Stand-by/power saving mode:

- When the cycle ends, the green "SLEEP" indicator on the control panel lights up and the LED display flashes "93". The system is now in Stand-By mode. After a while, it shuts down and sets itself in a Power Saving mode. The system will automatically turn itself back on in 24 hours, starting its daily cycle of chlorine production.
- The "SLEEP" indicator stays on, while the system is in the Power Saving mode. The LED display however, goes blank after 5 minutes. Press any button (  or  ) to view the last LED code.







### 7. Running the pump alone without the Saltwater System:

To run the pump alone without the Saltwater System function, press and hold both  and  buttons until you hear a "beep", the LED display will show "FP". The pump is now operating alone. NOTE: The pump cannot be operated alone under an automatic timer mode. To stop the pump, manually turn the switch OFF.



#### To bring back the initial automatic operating cycle setting of the Saltwater System:

- If the LED display shows "FP", press the  button and the operating hours set previously will begin flashing, press the  button again or simply wait 1 minute, and the LED will stay illuminated. The Saltwater System cycle repeats again.
- If the unit is OFF, turn the switch ON, the LED display shows "FP", press the  button and the operating hours set previously will begin flashing, press the  button again or simply wait 1 minute, and the LED will stay illuminated. The Saltwater System cycle repeats again.

## LED CODE CHART

LED Reading	Definitions
FP	Filter Pump Working Mode
80	Boost Mode
00	Stand-By Mode (Start-up)
01	Minimum Operating Hour (1 hour remaining)
02	Operating Hours (2 hours remaining)
03	Operating Hours (3 hours remaining)
04	Operating Hours (4 hours remaining)
05	Operating Hours (5 hours remaining)
06	Operating Hours (6 hours remaining)
07	Operating Hours (7 hours remaining)
08	Operating Hours (8 hours remaining)
09	Operating Hours (9 hours remaining)
10	Operating Hours (10 hours remaining)
11	Operating Hours (11 hours remaining)
12	Maximum Operating Hours (12 hours remaining)
90	Alarm Code (Low Pump Flow/No Pump Flow)
91	Alarm Code (Low Salt Level)
92	Alarm Code (High Salt Level)
93	Stand-By Mode (Operating Process finished)
"BLANK"	No Power or "Power Saving Mode" waiting to start next Saltwater System cycle.

Operation is subject to the following two conditions: (1) this device may not cause interference, and (2) this device must accept any interference, including interference that may cause undesired operation of the device.

Changes or modifications not expressly approved by the party responsible for compliance could void the user's authority to operate the equipment.

This equipment has been tested and found to comply with the limits for Class B digital device, pursuant to part 15 of the FCC Rules. These limits are designed to provide reasonable protection against harmful interference in a residential installation. This equipment generates, uses and can radiate radio frequency energy and, if not installed and used in accordance with the instructions, may cause harmful interference to radio communications. However, there is no guarantee that interference will not occur in a particular installation. If this equipment does cause harmful interference to radio or television reception, which can be determined by turning the equipment off and on, the user is encouraged to try to correct the interference by one or more of the following measures:

- Reorient or relocate the receiving antenna.
- Increase the separation between the equipment and the receiver.
- Connect the equipment into an outlet on a circuit different from that to which the receiver is connected.
- Consult the dealer or an experienced radio/TV technician for help.

## MAINTENANCE

### **WARNING**

Always unplug this product from the electrical outlet before removing, cleaning, servicing or making any adjustment to the product.

### **IMPORTANT**

Close plunger valves on your pool or insert black hat-like plugs in strainer opening to prevent water spillage. Open plunger valves or remove plugs when maintenance is completed.

## FLOW SENSOR CLEANING

1. In a counter-clockwise motion unscrew the collar of the flow sensor (**11**) and remove it from the electrolytic cell conduit. See "Part Reference".
2. If deposits and debris are seen on the surface of the flow sensor, then use a garden hose to wash it off.

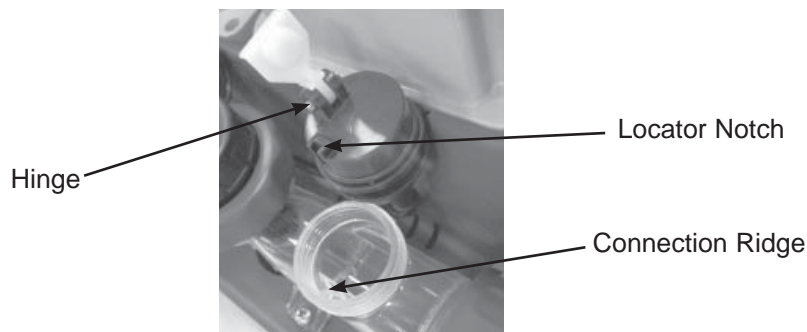

3. If flushing with water does not remove the deposits, use a plastic brush to clean the surface and the hinge if necessary. Do not use a metal brush.
4. After the flow sensor has been inspected and cleaned, align the locator notch on the flow sensor to the connection ridge in the conduit. Now turn the collar in a clockwise motion, tightening the sensor back into its position. Do not over tighten.

## TITANIUM AND E.C.O. ELECTRODES CLEANING

The titanium electrode and E.C.O. electrodes have a self cleaning function incorporated into the electronic control's programming. In most cases this self cleaning action will keep the electrodes working at optimum efficiency. If the pool water is hard (high mineral content) the electrodes may require periodic manual cleaning. To maintain maximum performance, we recommend that you open and visually inspect the titanium and E.C.O. electrodes (**4 & 5**) monthly.

The following steps provide instructions on how to clean your cell.

## MAINTENANCE (continued)

1. Switch off the unit, unplug the power cord from the electrical socket.
2. Turn both plunger valve handles fully clockwise until they stop. This closes the valve, prevents the water from flowing out of the pool.
3. Disconnect the hose with nut **(8)** from the Saltwater System, and assemble the cell cover **(30)** at the side of the cell.

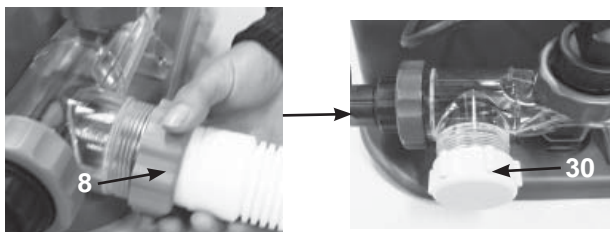

4. Unscrew the collar of the E.C.O. electrode **(14)** and pull out the E.C.O. electrode from the electrolytic cell **(13)** housing.

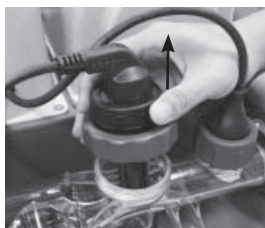

5. Pour kitchen grade vinegar into the electrolytic cell **(13)** to immerse the titanium and E.C.O. electrodes. Soak for 1 hour.

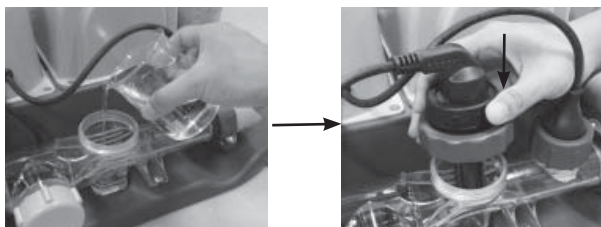

6. Open one side of the cell cover **(30)**, drain and properly dispose of the vinegar. Connect the hose which goes from the pool to the cell. Flush the electrolytic cell housing with the pool water.



7. Reverse steps 3, 4, 5 and 6 to reconnect the electrolytic cell.

## CLEANING OR REPLACING FILTER CARTRIDGES

**It is recommended that the filter cartridge be replaced at least every 2 weeks.**

1. Make sure the unit is turned off, and disconnect the power cord from the electrical outlet.
2. Turn both plunger valve handles fully clockwise until they stop. This closes the valve, prevents the water from flowing out of the pool.
3. Gently turn both air release valves **(1 & 7)** once or twice in a counter-clockwise direction. The housing cover can now be easily removed.
4. In a counter-clockwise direction remove the filter housing collar **(3)**. Place it in a safe location.
5. Remove the housing cover **(4)**.
6. Now remove the used filter cartridge.
7. Examine the inside of the filter housing.
8. If dirt or sediment is located on the bottom of the housing then:
  - A. In a counter-clockwise motion gently unscrew and remove the sediment valve **(1)** located at the bottom of the housing. Place it in a safe place.
  - B. With a bucket of water or a garden hose pour water into the housing flushing out the sediment.
  - C. Screw back the sediment valve **(1)** in a gentle clockwise motion. Do not over-tighten.
9. Place a new cartridge filter in the housing.
10. Return the housing cover **(4)** to its installed position and in a clockwise direction rescrew the housing collar **(3)** onto the filter housing.
11. Turn both plunger valve handles fully counter-clockwise until they stop. This opens the valve, allowing water to flow into the filter pump.
12. Reconnect the power cord.
13. Turn on the unit.
14. When the trapped air has escaped through the air release valves gently retighten the valves **(1 & 7)** in a clockwise direction.

## MAINTENANCE (continued)

### INTEX<sup>®</sup> TEST STRIPS (PACKED WITH THE PRODUCT)

The Test Strips can test the "Free Chlorine", "pH", "Calcium Hardness" and "Total Alkalinity" levels at the same time. We recommend that you test the water chemistry weekly, and maintain the chlorine concentration at 0.5-3 ppm.

#### Directions and Use

1. Dip the entire strip into the water and remove immediately.
2. Hold the strip level for 15 seconds. Do not shake excess water from the strip.
3. Now compare the strip pad to the color chart on the packaging label. If necessary, adjust the chemical level in the pool water. It is very important, to use the proper technique when testing the water's chemical level. Read and follow the written strip instructions carefully.

### LONG TERM STORAGE

1. Disconnect the power cord from the electrical outlet.
2. After the pool is completely empty, disconnect the Saltwater System from the hoses by reversing the installation instructions.
3. Air-dry the unit before you store it. This might be a good time to visually inspect and clean the electrolytic cell.
4. Store the unit and accessories in a dry place. The temperature should be controlled, between 32 degrees Fahrenheit (0 degrees Celsius) and 97 degrees Fahrenheit (36 degrees Celsius).
5. The original package can be used for storage.



## POOL MAINTENANCE & CHEMICAL DEFINITIONS

Preferred Water Chemistry Reading			
	Minimum	Ideal	Maximum
Free Chlorine	0	0.5 - 3.0 ppm	5.0 ppm
Combined Chlorine	0	0 ppm	0.2 ppm
pH	7.2	7.4 - 7.6	7.8
Total Alkalinity	40 ppm	80 ppm	120 ppm
Calcium Hardness	50 ppm	100 - 250 ppm	350 ppm
Stabilizer (Cyanuric Acid)	10 ppm	20 - 40 ppm	50 ppm

HClO - A very effective killer of algae and bacteria known as hypochlorous acid.

<b>Free Chlorine</b> -	Is the sanitizer (HClO) present in pool water.
<b>Combined Chlorine</b> -	Is formed by the reaction of free Chlorine with ammonia wastes. Result if too high - Sharp chlorinous odor, eye irritation.
<b>pH</b> -	A value that indicates how acidic or basic a solution is. Result if too low - Corroded metals, eye & skin irritation, destruction of total alkalinity. Result if too high - Scale formation, cloudy water, shorter filter runs, eye & skin irritation, poor Chlorine efficiency.
<b>Total Alkalinity</b> -	Indicates the degree of the water's resistance to change in pH. It determines the speed and ease of pH change, so always adjust total alkalinity before adjusting the pH level. Result if too low - Corroded metals, eye & skin irritation. Low alkalinity will cause the pH to be unstable. Any chemical added to the water will have an affect on pH. Result if too high - Scale formation, cloudy water, eye & skin irritation, poor Chlorine efficiency.
<b>Calcium Hardness</b> -	Refers to the amount of calcium and magnesium dissolved in the water. Result if too high - Eye & skin irritation, difficulty balancing water and poor chlorine efficiency. Scale will form and will cause the water to become cloudy.
<b>Stabilizer (Cyanuric Acid)</b> -	Stabilizers extend the life of Chlorine in swimming pools.

- Do not add pool chemicals directly to the skimmer. This may damage the cell.
- Maintaining a high salt and sanitizer levels above recommended range can contribute to corrosion of pool equipment.
- Check the expiry date of the test kit as the test results may be inaccurate if the kit is used after that date.
- If, due to heavy pool usage, it is required to increase the sanitizer level, then use a chemical based on Trichloro-s-triazinetrione or sodium dichloro-s-triazinetrione dihydrate.







## TROUBLESHOOTING GUIDE

PROBLEM	CAUSE	SOLUTION
FILTER MOTOR FAILS TO START	<ul style="list-style-type: none"> <li>• The motor is not plugged in.</li> <li>• Switch is not turn on.</li> <li>• The GFCI circuit breaker is tripped.</li> <li>• Motor too hot and overload protection is shut off.</li> </ul>	<ul style="list-style-type: none"> <li>• Filter cord must be plugged into a 3 wire outlet that is protected by a Class A Ground Fault Circuit Interrupter, or RCD.</li> <li>• Reset circuit breaker. If circuit breaker trips repeatedly, your electrical system may have a defect. Turn off circuit breaker and call an electrician to correct the problem.</li> <li>• Let motor cool down.</li> </ul>
FILTER DOESN'T CLEAN POOL	<ul style="list-style-type: none"> <li>• Improper sanitizer or pH levels.</li> <li>• Filter cartridge is dirty.</li> <li>• Damaged cartridge.</li> <li>• Excessively dirty pool.</li> <li>• The strainer screen is restricting the water flow.</li> </ul>	<ul style="list-style-type: none"> <li>• Adjust the sanitizer and pH level. Consult your local swimming pool supply stores.</li> <li>• Clean or replace cartridge.</li> <li>• Check the cartridge for holes. Replace if damaged.</li> <li>• Operate the filter for longer periods.</li> <li>• Clean the strainer screen at the inlet.</li> </ul>
FILTER DOESN'T PUMP WATER OR FLOW IS VERY SLOW	<ul style="list-style-type: none"> <li>• Clogged inlet or discharge.</li> <li>• An air leak on the intake line.</li> <li>• Scale or buildup on cartridge.</li> <li>• Excessively dirty pool.</li> <li>• Dirty filter cartridge.</li> <li>• Inlet threaded air connector connected to the wrong hole on the liner.</li> </ul>	<ul style="list-style-type: none"> <li>• Clear any obstructions in the intake hose by discharging it inside pool wall.</li> <li>• Tighten hose nuts, check hoses for damage, check pool water level.</li> <li>• Replace cartridge.</li> <li>• Clean cartridge more often.</li> <li>• Clean inside the plunger valve.</li> <li>• Pull valve handle to full upright position.</li> <li>• Make sure the inlet threaded air connector is connected to the pool inlet upper hole.</li> </ul>
PUMP DOESN'T WORK	<ul style="list-style-type: none"> <li>• Low water level.</li> <li>• Strainer screen plugged up.</li> <li>• An air leak on the intake hose.</li> <li>• An air lock inside the cartridge chamber and motor chamber.</li> <li>• Service light on.</li> </ul>	<ul style="list-style-type: none"> <li>• Fill pool to correct water level.</li> <li>• Clean strainer screens at pool inlet.</li> <li>• Tighten hose nuts, check hose for damage.</li> <li>• Clear any sticks or leaves in the intake hose.</li> <li>• Turn and pull valve handle to full upright position.</li> <li>• Unscrew two air release valve on the chamber to fullfill water.</li> <li>• Contact Intex Service Center.</li> </ul>
TOP COVER LEAKING	<ul style="list-style-type: none"> <li>• O-ring missing.</li> <li>• Cover is not tight.</li> <li>• Filter cartridge is dirty.</li> </ul>	<ul style="list-style-type: none"> <li>• Remove cover &amp; check for O-ring.</li> <li>• Tighten cover (Manually).</li> <li>• Replace or clean cartridge.</li> </ul>
HOSE LEAKING	<ul style="list-style-type: none"> <li>• Hose nuts are not well-fitted.</li> </ul>	<ul style="list-style-type: none"> <li>• Tighten or reinstall hose nut.</li> </ul>
AIR LOCK	<ul style="list-style-type: none"> <li>• There's air trapped in the pump housing and inlet hose.</li> <li>• The inlet and outlet hoses connection are reversed.</li> </ul>	<ul style="list-style-type: none"> <li>• Open air release valves, lift and lower the inlet hose until water starts to flow out of the valve, then close it.</li> <li>• The lower position of pool outlet connects to filter pump water inlet. The upper position of pool inlet connects to filter pump water outlet.</li> </ul>
INLET TREADED AIR CONNECTOR / AIR JET VALVE LEAKING	<ul style="list-style-type: none"> <li>• Plunger valve not well-fitted.</li> <li>• Air jet valve is not tight and facing up.</li> <li>• Air jet valve internal seal blocked.</li> <li>• Air jet valve internal seal dirty.</li> <li>• Air jet valve broken.</li> </ul>	<ul style="list-style-type: none"> <li>• Tighten or reinstall plunger valve.</li> <li>• Tighten air jet valve and make sure it's facing up.</li> <li>• Turn pump ON and run for few seconds, then turn OFF, repeat 3 times.</li> <li>• Remove air jet valve, flush dirt out with water and replace valve back.</li> <li>• Replace a new air jet valve.</li> </ul>

## TROUBLESHOOTING GUIDE (continued)

PROBLEM	CAUSE	SOLUTION
INSUFFICIENT CHLORINE	<ul style="list-style-type: none"> <li>• Insufficient operating hours of the Saltwater System.</li> <li>• The salt level in the pool water is less than 2000ppm. This is insufficient.</li> <li>• Chlorine loss due to intense sunlight exposure.</li> <li>• The bather load has increased.</li> <li>• Clogged or dirty electrolytic cell.</li> <li>• High UV level exposure.</li> </ul>	<ul style="list-style-type: none"> <li>• Increase the daily Saltwater System operating time. See "Operating Instructions".</li> <li>• Check the salt level with the Test Kit. Adjust as needed. See "Salt &amp; Pool Water Volumes".</li> <li>• Use a pool cover when the pool is not in use and/or when the unit is operating.</li> <li>• Increase the daily Saltwater System operating time. See "Operating Instructions".</li> <li>• Remove the cell for inspection, clean it if necessary. See "Maintenance".</li> <li>• Cover the pool with a pool cover for 2 days with the device running and then test the water using the test strips.</li> <li>• If the pool is clean and clear, add stabilizer to the water and then test the water with the device running.</li> </ul>
WHITE FLAKES IN THE WATER	<ul style="list-style-type: none"> <li>• Excessive calcium hardness is present in pool water.</li> </ul>	<ul style="list-style-type: none"> <li>• Drain about 20 to 25% of the pool water and add fresh water to decrease the calcium hardness. Inspect the electrolytic cell for scale buildup. Clean the electrolytic cell if necessary.</li> </ul>
NO LED DISPLAY	<ul style="list-style-type: none"> <li>• No power supply.</li> <li>• RCD/GFCI has not reseted.</li> <li>• A power fuse has blown.</li> <li>• LED failure.</li> </ul>	<ul style="list-style-type: none"> <li>• Reset the RCD/GFCI.</li> <li>• Contact Intex Service Center.</li> <li>• Contact Intex Service Center.</li> </ul>

## TROUBLESHOOTING GUIDE (continued)

LED PANEL CODE	PROBLEM	SOLUTION
LED Panel Code Flash & Alarm On ( <b>NOTE:</b> Always turn off the power before cleaning and servicing).		
	1. Circulation line is blocked.	<ul style="list-style-type: none"> <li>If your unit has plunger valves, ensure that they are open.</li> <li>Clear your filter cartridge and cell from debris and dirt. See "Maintenance".</li> <li>Release all trapped air in the circulation line. See the filter pump manual.</li> </ul>
	2. Incorrect inlet and outlet hose direction.	<ul style="list-style-type: none"> <li>Check the direction of the inlet and the outlet hose. Reverse the hoses if necessary. See "Set Up Instructions".</li> </ul>
	3. Scale on the flow sensor.	<ul style="list-style-type: none"> <li>Clean the flow sensor, paying special attention to the hinge. See "Maintenance".</li> </ul>
	4. Flow sensor cord is loose.	<ul style="list-style-type: none"> <li>Plug the flow sensor firmly into the flow sensor receptacle.</li> </ul>
	5. Inner timer confliction between filter pump and saltwater system.	<ul style="list-style-type: none"> <li>Reset both timers on the filter pump and saltwater system. See "Boost Cycle".</li> </ul>
	6. Flow sensor failure.	<ul style="list-style-type: none"> <li>Contact Intex Service Center.</li> </ul>
	1. Dirt or scale on titanium plates.	<ul style="list-style-type: none"> <li>Remove the electrolytic cell for inspection. Clean it if necessary. See "Maintenance".</li> </ul>
	2. Low salt level / No salt.	<ul style="list-style-type: none"> <li>Add salt. See "Salt &amp; Pool Water Volumes".</li> </ul>
	3. Electrolytic cell cord is loose.	<ul style="list-style-type: none"> <li>Ensure that the cell cord is plugged firmly into the cell housing receptacle.</li> </ul>
	4. Possible electrolytic cell failure.	<ul style="list-style-type: none"> <li>Contact Intex Service Center. Replace the cell if needed.</li> </ul>
	1. High salt level.	<ul style="list-style-type: none"> <li>Partially drain the pool and refill it with fresh water. See "Salt &amp; Pool Water Volumes".</li> </ul>
	1. Display and all lights are off - the system does not power up.	<ul style="list-style-type: none"> <li>Household voltage is too high or too low (<math>\pm 20\%</math>). Check the voltage is within the range stated on the device housing.</li> <li>Contact Intex Service Center.</li> </ul>

**IMPORTANT**

If you continue to experience difficulty, please contact our Consumer Service Department for assistance. See separate "Authorized Service Centers" sheet.

## GENERAL AQUATIC SAFETY

**Water recreation is both fun and therapeutic. However, it involves inherent risks of injury and death. To reduce your risk of injury, read and follow all product, package and package insert warnings and instructions. Remember, however, that product warnings, instructions and safety guidelines cover some common risks of water recreation, but do not cover all risks and dangers.**

**For additional safeguards, also familiarize yourself with the following general guidelines as well as guidelines provided by nationally recognized Safety Organizations:**

- Demand constant supervision. A competent adult should be appointed as a “lifeguard” or water watcher, especially when children are in and around the pool.
- Learn to swim.
- Take the time to learn CPR and first aid.
- Instruct anyone who is supervising pool users about potential pool hazards and about the use of protective devices such as locked doors, barriers, etc.
- Instruct all pool users, including children what to do in case of an emergency.
- Always use common sense and good judgement when enjoying any water activity.
- Supervise, supervise, supervise.

**For additional information on safety, please visit**

- **The Association of Pool and Spa Professionals: The Sensible Way to Enjoy Your Aboveground/Onground Swimming Pool** [www.nspi.org](http://www.nspi.org)
- **American Academy of Pediatrics: Pool Safety for Children** [www.aap.org](http://www.aap.org)
- **Red Cross** [www.redcross.org](http://www.redcross.org)
- **Safe Kids** [www.safekids.org](http://www.safekids.org)
- **Home Safety Council: Safety Guide** [www.homesafetycouncil.org](http://www.homesafetycouncil.org)
- **Toy Industry Association: Toy Safety** [www.toy-tia.org](http://www.toy-tia.org)

## LIMITED WARRANTY

Your Krystal Clear Saltwater System® has been manufactured using the highest quality materials and workmanship. All Intex products have been inspected and found free of defects prior to leaving the factory. This Limited Warranty applies only to the Krystal Clear Saltwater System® and accessories listed below.

The provisions of this Limited Warranty apply only to the original purchaser and is not transferable. This Limited Warranty is valid for the period noted below from the date of the initial retail purchase. Keep your original sales receipt with this manual, as proof of purchase will be required and must accompany warranty claims or the Limited Warranty is invalid.

Krystal Clear Saltwater System® Warranty – 2 Years  
Titanium Electrode Warranty – 1 Year  
E.C.O. electrode Warranty – 1 Year  
Hoses, Plunger Valves & Fittings Warranty – 180 days

If a manufacturing defect is found within the periods noted above, please contact the appropriate Intex Service Center listed in the separate "Authorized Service Centers" sheet. The Service Center will determine the validity of the claim. If the Service Center directs you to return the product, please carefully package the product and send with shipping and insurance prepaid to the Service Center. Upon receipt of the returned product, the Intex Service Center will inspect the item and determine the validity of the claim. If the provisions of this warranty cover the item, the item will be repaired or replaced at no charge.

Any and all disputes regarding the provisions of this Limited Warranty shall be brought before an informal dispute settlement board and unless and until the provisions of these paragraphs are carried forth, no civil action may be instituted. The methods and procedures of this settlement board shall be subject to the rules and regulations set forth by the Federal Trade Commission (F.T.C.). IMPLIED WARRANTIES ARE LIMITED TO THE TERMS OF THIS WARRANTY AND IN NO EVENT SHALL INTEX, THEIR AUTHORIZED AGENTS OR EMPLOYEES BE LIABLE TO THE BUYER OR ANY OTHER PARTY FOR DIRECT OR CONSEQUENTIAL DAMAGES OR LIABILITIES. Some states, or jurisdictions do not allow the exclusion or limitation of incidental or consequential damages, so the above limitation or exclusion may not apply to you.

This Limited Warranty does not apply if the products are subject to negligence, abnormal use or operation, accident, improper operation, improper voltage or current contrary to operating instructions, or to damage by circumstances beyond Intex's control, including but not limited to, ordinary wear and tear and damage caused by exposure to fire, flood, freezing, rain, or other external environmental forces. This Limited Warranty applies only to those parts and components sold by Intex. The Limited Warranty does not cover unauthorized alterations, repairs or disassembly by anyone other than Intex Service Center personnel.

**DO NOT GO BACK TO THE PLACE OF PURCHASE FOR RETURN OR REPLACEMENT. IF YOU ARE MISSING PARTS OR NEED ASSISTANCE, PLEASE CALL US TOLL-FREE (FOR U.S. AND CANADIAN RESIDENTS): 1-800-234-6839 OR VISIT OUR WEBSITE: WWW.INTEXSTORE.COM.**

Proof of Purchase must accompany all returns or the warranty claim will be invalid.