

English

155
PO

**IMPORTANT
SAFETY RULES**
Read, understand, and follow
all instructions carefully before
installing and using this product.

LED Pool-Wall Light

Model WL3110

110 - 120 Volt ~, 60 Hz



For illustrative purposes only.

Don't forget to try these other fine Intex products: pools, pool accessories, inflatable pools and in-home toys, airbeds and boats available at fine retailers or visit our website. Due to a policy of continuous product improvement, Intex reserves the right to change specifications and appearance, which may result in updates to the instruction manual, without notice



IMPORTANT!
DO NOT RETURN PRODUCT TO STORE

To purchase parts and accessories or to obtain non-technical assistance,

Visit www.intexcorp.com

For technical assistance and missing parts call us toll-free (for U.S. and Canadian Residents):

1-800-234-6839

Monday through Friday, 8:30am to 5:00pm Pacific Time

155-*PO-R0-1306

OWNER'S MANUAL

Warnings..... 3-4

Parts List & References..... 4

Setup Instructions..... 5-6

**Installation on Intex
Sequoia Spirit Wood-Grain Pools..... 6**

Long Term Storage..... 6

Troubleshooting Guide..... 7

General Aquatic Safety..... 8

Limited Warranty..... 9

This manual contains important safety and operating instructions for power units.

TABLE OF CONTENTS

IMPORTANT SAFETY RULES

Read, Understand and Follow All Instructions Carefully Before Installing and Using this Product.

READ AND FOLLOW ALL INSTRUCTIONS**⚠ WARNING**

- To reduce the risk of electric shock, do not open this product.
- To reduce the risk of injury, do not permit children to use this product. Always supervise children and those with disabilities.
- Children must stay away from this product and electrical cord(s).
- Assembly and disassembly by adults only.
- Risk of electric shock. Connect this product only to a grounding type receptacle protected by a ground-fault circuit interrupter (GFCI). Contact a qualified electrician if you cannot verify that the receptacle is protected by a GFCI.
- Always unplug this product from the electrical outlet before removing, cleaning, servicing or making any adjustment to the product.
- Do not bury the electrical cord. Locate the cord where it will not be damaged by lawn mowers, hedge trimmers and other equipment.
- To reduce the risk of electric shock, replace damaged cord immediately. Use a qualified electrician to replace the cord. Never attempt to service the product yourself.
- To reduce the risk of electric shock, do not use extension cords, timers, plug adaptors or converter plugs to connect unit to electric supply; provide a properly located outlet.
- Do not attempt to plug in or unplug this product while standing in water or when your hands are wet.
- Do not use an appliance leakage current interrupter (ALCI) in place of a GFCI since the ALCI will not protect people.
- Do not immerse the transformer and the external transmitter unit into water.
- Do not throw or drop the product.
- Do not stare directly at the light emitted by this product.
- Do not operate the product if transmitter housing or pool light lens is cracked or showing water leakage; remove from pool or water immediately.
- Do not insert fingers or objects into the openings and holes.
- Strong magnets. Keep this device away from mobile phone and other electronic gadgets.
- Keep the transformer more than 11.5 feet (3.5m) away from the pool.
- Keep the plug of this product more than 11.5 feet (3.5m) away from the pool.
- For a cord-connected or direct plug-in unit, do not use in a bathroom.
- Risk of Electric Shock. When used outdoors, install only to a covered Class A GFCI protected receptacle that is weatherproof with the power unit connected to the receptacle. If one is not provide, contact a qualified electrician for proper installation. Ensure that the power unit and cord do not interfere with completely closing the receptacle cover.
- Risk of Fire. Installation involves special wiring methods to run wiring through a building structure. Consult a qualified electrician.
- This product is intended to be used only for the purposes described in the manual!

FAILURE TO FOLLOW THESE WARNINGS MAY RESULT IN PROPERTY DAMAGE, ELECTRIC SHOCK, ENTANGLEMENT OR OTHER SERIOUS INJURY OR DEATH.

⚠ CAUTION

This product is for use with storable pools only. Do not use with permanently-installed pools. A storable pool is constructed so that it is capable of being readily disassembled for storage and reassembled to its original integrity. A permanently-installed pool is constructed in or on the ground or in a building such that it cannot be readily disassembled for storage.

These product warnings, instructions and safety rules provided with the product represent some common risks of water recreation devices and do not cover all instances of risk and danger. Please use common sense and good judgement when enjoying any water activity.

SAFETY RULES

SAVE THESE INSTRUCTIONS**Page 3**

IMPORTANT SAFETY RULES (continued)

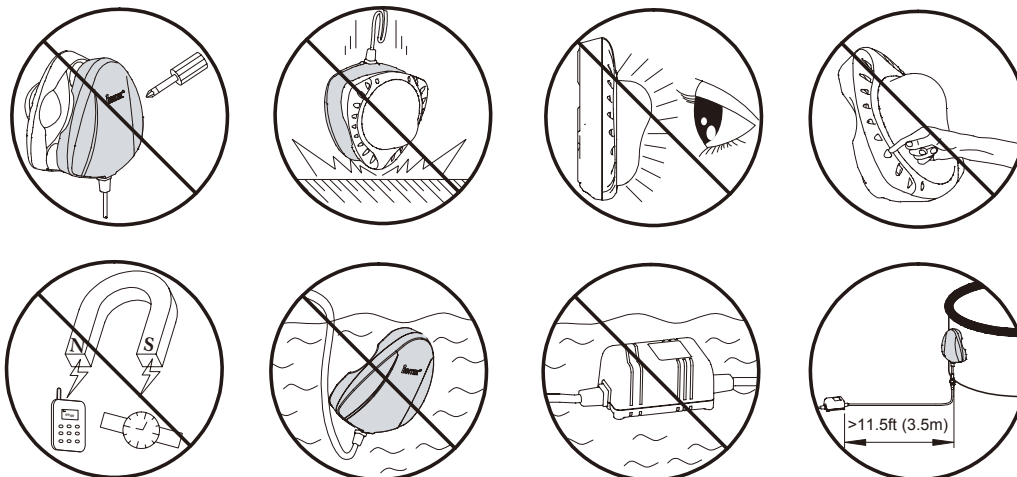

PARTS REFERENCES

Before assembling your product, please take a few minutes to check the contents and become familiar with all the parts.

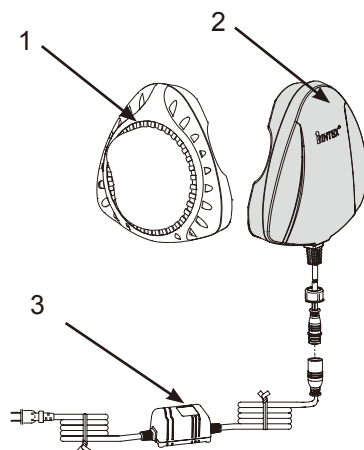

NOTE: Drawings for illustration purpose only. Actual product may vary. Not to scale.

REF. NO.	DESCRIPTION	QTY.	SPARE PART NO.
1	POOL LIGHT	1	11263
2	TRANSMITTER	1	11264
3	TRANSFORMER	1	11266

SAFETY RULES & PARTS REFERENCE

SETUP INSTRUCTIONS

This product is specially designed for above ground pool. The LED pool-wall light uses magnetic technology to create a light system that safely generates low voltage current through the pool's sidewall to a powerful LED light inside the pool.

⚠ WARNING

- Always unplug this product from the electrical outlet before removing, cleaning, servicing or making any adjustment to the product.
- Do not operate the product if transmitter housing or pool light lens is cracked or showing water leakage; remove from pool or water immediately.
- Never place the power transmitter in water.

IMPORTANT

- This product is for use with above ground non-steel wall pools with a thickness of 1mm (0.04 in) or less.
- Do not use this product as a free standing light.

1. Separate the pool light (1) from the transmitter (2) by hand through the side opening groove. **See drawing (1 & 2).**

CAUTION: To avoid finger pinch or injury, always separate the pool light from the transmitter through the side opening groove.

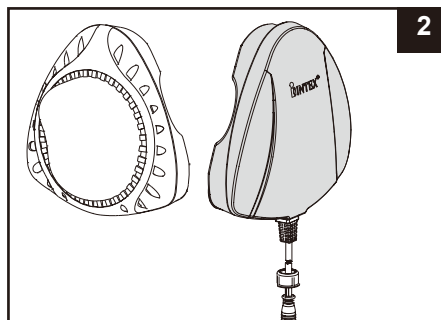
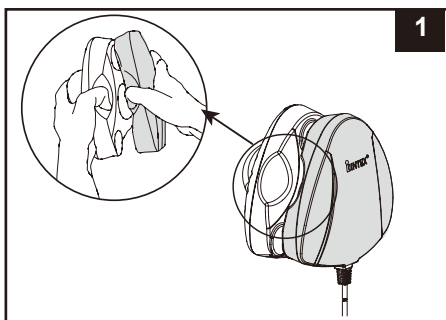

2. Place the transmitter (2) on the outside of the pool wall and the pool light (1) on the inside of the pool wall submerged in water. Ensure the transmitter magnetic poles are properly aligned with the magnetic poles on the pool light unit. **See drawing (3).**

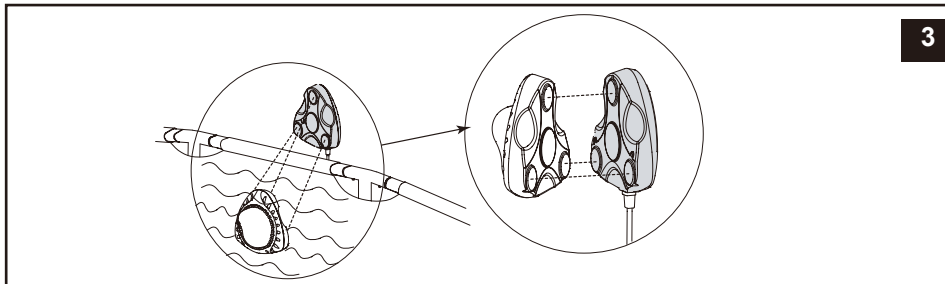

3. Adjust the position of the pool light by manually sliding the transmitter position sideways and/or vertically.
4. Plug the assembled unit to an electrical outlet protected by a ground-fault circuit interrupter (GFCI).

SETUP INSTRUCTIONS (continued)

Installation on Intex Sequoia Spirit Wood-Grain Pools:

Unscrew the bolts from the section where the LED pool-wall light will be installed, and remove the clamp covers, the top board and the side boards. Refer to the Wood-Grain Pool owner's manual for details. For better installation, it is recommended to remove at least 3 side board panels. Follow above setup instructions 1 to 4.

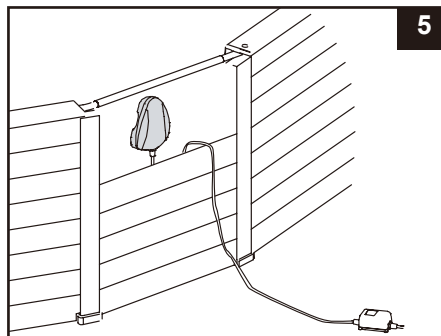
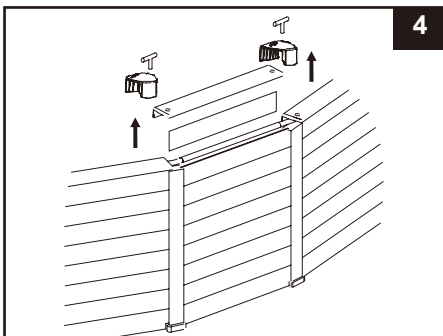

LONG TERM STORAGE

In areas where freezing temperatures occur, there is risk of ice damage to the product. It is recommended to remove, clean and store the product in a safe place when temperature drops below 0 degrees Celsius (32 degrees Fahrenheit).

1. Unplug the power cord from the electrical socket.
2. Remove the transmitter (2) from the outside of the pool wall first, the pool light (1) unit will automatically float to the surface for easy retrieval, then remove the pool light from the water.
IMPORTANT: To prevent damage to the transmitter from falling to the ground, always remove the transmitter first before removing the pool light unit.
3. If deposits or debris are seen inside the holes of the pool light, use a garden hose to flush them out. Do not scrape the pool-wall light or use brush to clean it.
4. Thoroughly air-dry all components before storage.
5. Store the product and accessories in a dry, temperature controlled location between 32 degrees Fahrenheit (0 degrees Celsius) and 104 degrees Fahrenheit (40 degrees Celsius).
6. The original packaging can be used for storage.

TROUBLE SHOOTING GUIDE

PROBLEM	CAUSE	SOLUTION
DIFFICULT TO ALIGN THE POOL LIGHT AND THE TRANSMITTER	<ul style="list-style-type: none"> Wrong orientation, magnetic poles are not aligned correctly. 	<ul style="list-style-type: none"> Rearrange the orientation of the pool light and the transmitter. See "setup instructions".
THE LED POOL-WALL LIGHT DOES NOT LIGHT UP	<ul style="list-style-type: none"> The power cord is loose. 	<ul style="list-style-type: none"> Plug the cord firmly into the electrical outlet. Tighten the intermediate connection between the transmitter and the transformer.
	<ul style="list-style-type: none"> The GFCI is tripped. 	<ul style="list-style-type: none"> Contact Intex Service Center.
	<ul style="list-style-type: none"> Wrong orientation and alignment between the pool light and the transmitter. 	<ul style="list-style-type: none"> Rearrange the orientation of the pool light and the transmitter. See "setup instructions".
	<ul style="list-style-type: none"> Water inside pool light unit. Possible transmitter or transformer failure. 	<ul style="list-style-type: none"> Contact Intex Service Center.
THE POOL LIGHT UNIT DOES NOT FLOAT	<ul style="list-style-type: none"> Water inside the pool light unit. 	<ul style="list-style-type: none"> Contact Intex Service Center.

IMPORTANT

If you continue to experience difficulty, please contact our Consumer Service Department for assistance. See separate "Authorized Service Centers" sheet.

Operation is subject to the following two conditions: **(1)** this device may not cause interference, and **(2)** this device must accept any interference, including interference that may cause undesired operation of the device.

Changes or modifications not expressly approved by the party responsible for compliance could void the user's authority to operate the equipment.

This equipment has been tested and found to comply with the limits for Class B digital device, pursuant to part 15 of the FCC Rules. These limits are designed to provide reasonable protection against harmful interference in a residential installation. This equipment generates, uses and can radiate radio frequency energy and, if not installed and used in accordance with the instructions, may cause harmful interference to radio or television reception, which can be determined by turning the equipment off and on, the user is encouraged to try to correct the interference by one or more of the following measures:

- Reorient or relocate the receiving antenna.
- Increase the separation between the equipment and the receiver.
- Connect the equipment into an outlet on a circuit different from that to which the receiver is connected.
- Consult the dealer or an experienced radio/TV technician for help.

TROUBLESHOOTING GUIDE

GENERAL AQUATIC SAFETY

Water recreation is both fun and therapeutic. However, it involves inherent risks of injury and death. To reduce your risk of injury, read and follow all product, package and package insert warnings and instructions. Remember, however, that product warnings, instructions and safety guidelines cover some common risks of water recreation, but do not cover all risks and or dangers.

For additional safeguards, also familiarize yourself with the following general guidelines as well as guidelines provided by nationally recognized Safety Organizations:

- Demand constant supervision. A competent adult should be appointed as a "lifeguard" or water watcher, especially when children are in and around the pool.
- Learn to swim.
- Take the time to learn CPR and first aid.
- Instruct anyone who is supervising pool users about potential pool hazards and about the use of protective devices such as locked doors, barriers, etc.
- Instruct all pool users, including children what to do in case of an emergency.
- Always use common sense and good judgement when enjoying any water activity.
- Supervise, supervise, supervise.

For additional information on safety, please visit

- **The Association of Pool and Spa Professionals: The Sensible Way to Enjoy Your Aboveground/Onground Swimming Pool**
www.nspi.org
- **American Academy of Pediatrics: Pool Safety for Children**
www.aap.org
- **Red Cross** www.redcross.org
- **Safe Kids** www.safekids.org
- **Home Safety Council: Safety Guide** www.homesafetycouncil.org
- **Toy Industry Association: Toy Safety** www.toy-tia.org

SAFETY IN YOUR POOL

Safe swimming depends on constant attention to the rules. The "NO DIVING" sign within this manual can be posted near your pool to help keep everyone alert to the danger. You may also wish to copy and laminate the sign for protection from the elements.

LIMITED WARRANTY

Your LED Pool-Wall Light has been manufactured using the highest quality materials and workmanship. All Intex products have been inspected and found free of defects prior to leaving the factory. This Limited Warranty applies only to the LED Pool-Wall Light.

The provisions of this Limited Warranty apply only to the original purchaser and is not transferable. This Limited Warranty is valid for a period of one **(1)** years from the date of the initial retail purchase. Keep your original sales receipt with this manual, as proof of purchase will be required and must accompany warranty claims or the Limited Warranty is invalid.

If a manufacturing defect is found within this one **(1)** years period, please contact the appropriate Intex Service Center listed in the separate "Authorized Service Centers" sheet. The Service Center will determine the validity of the claim. If the Service Center directs you to return the product, please carefully package the product and send with shipping and insurance prepaid to the Service Center. Upon receipt of the returned product, the Intex Service Center will inspect the item and determine the validity of the claim. If the provisions of this warranty cover the item, the item will be repaired or replaced at no charge.

Any and all disputes regarding the provisions of this Limited Warranty shall be brought before an informal dispute settlement board and unless and until the provisions of these paragraphs are carried forth, no civil action may be instituted. The methods and procedures of this settlement board shall be subject to the rules and regulations set forth by the Federal Trade Commission (F.T.C.). IMPLIED WARRANTIES ARE LIMITED TO THE TERMS OF THIS WARRANTY AND IN NO EVENT SHALL INTEX, THEIR AUTHORIZED AGENTS OR EMPLOYEES BE LIABLE TO THE BUYER OR ANY OTHER PARTY FOR DIRECT OR CONSEQUENTIAL DAMAGES OR LIABILITIES. Some states, or jurisdictions do not allow the exclusion or limitation of incidental or consequential damages, so the above limitation or exclusion may not apply to you.

This Limited Warranty does not apply if the LED Pool-Wall Light is subject to negligence, abnormal use or operation, accident, improper operation, improper voltage or current contrary to operating instructions, or to damage by circumstances beyond Intex's control, including but not limited to, ordinary wear and tear and damage caused by exposure to fire, flood, freezing, rain, or other external environmental forces. This Limited Warranty applies only to those parts and components sold by Intex. The Limited Warranty does not cover unauthorized alterations, repairs or disassembly by anyone other than Intex Service Center personnel.

DO NOT GO BACK TO THE PLACE OF PURCHASE FOR RETURN OR REPLACEMENT. IF YOU ARE MISSING PARTS OR NEED ASSISTANCE, PLEASE CALL US TOLL-FREE (FOR U.S. AND CANADIAN RESIDENTS): 1-800-234-6839.

Proof of Purchase must accompany all returns or the warranty claim will be invalid.